

03 SEP 26 AM 9:09

MARIE KRUTZFIELD  
RECORDER No Fee

J.D. TJEPKES, LS. JONES COUNTY ENGINEER'S OFFICE, 19501 HWY. 64, ANAMOSA, IOWA, 52205 (319)462-3785

# UNITED STATES PUBLIC LAND SURVEY CORNER CERTIFICATE

LAND SURVEY MONUMENTS SITUATED IN SECTION 13, TOWNSHIP 84  
NORTH, RANGE 4 WEST OF THE 5TH P.M., JONES COUNTY, IOWA

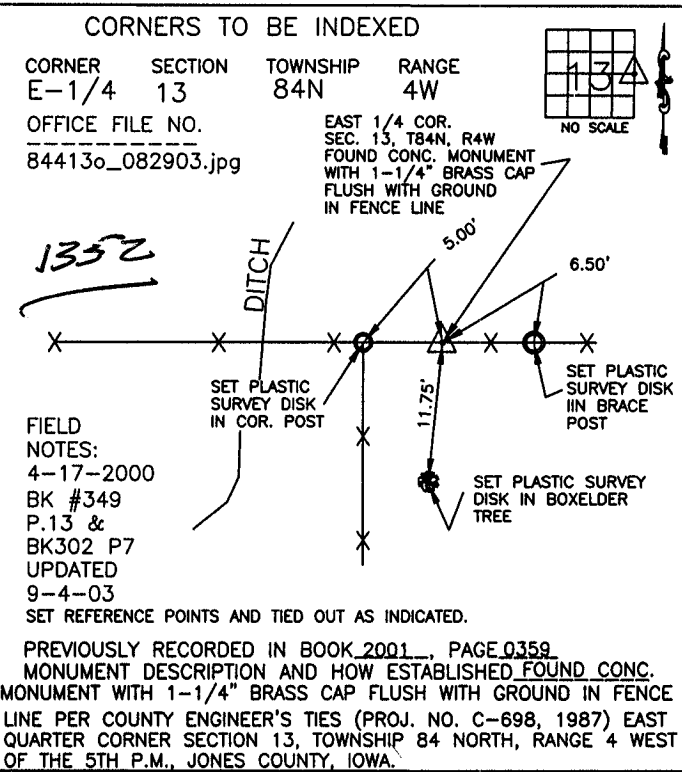
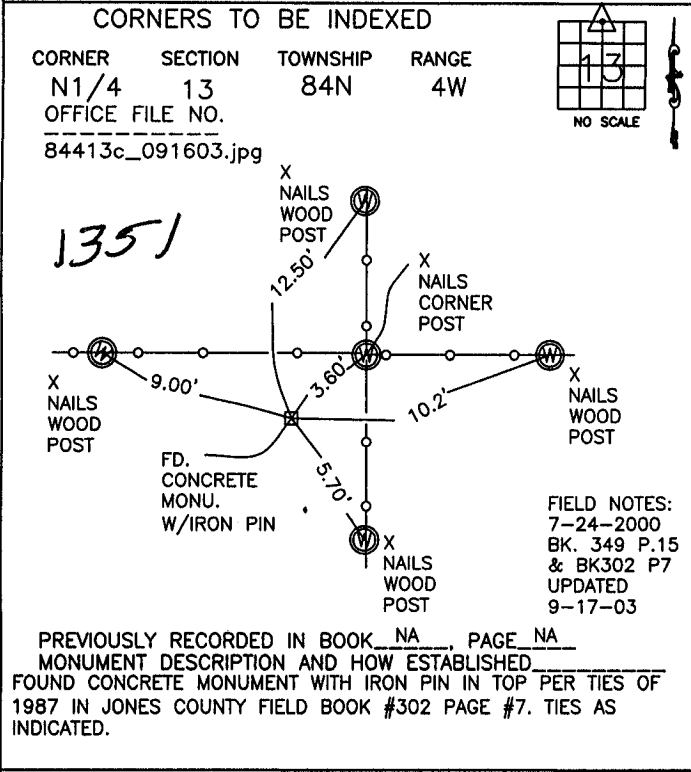
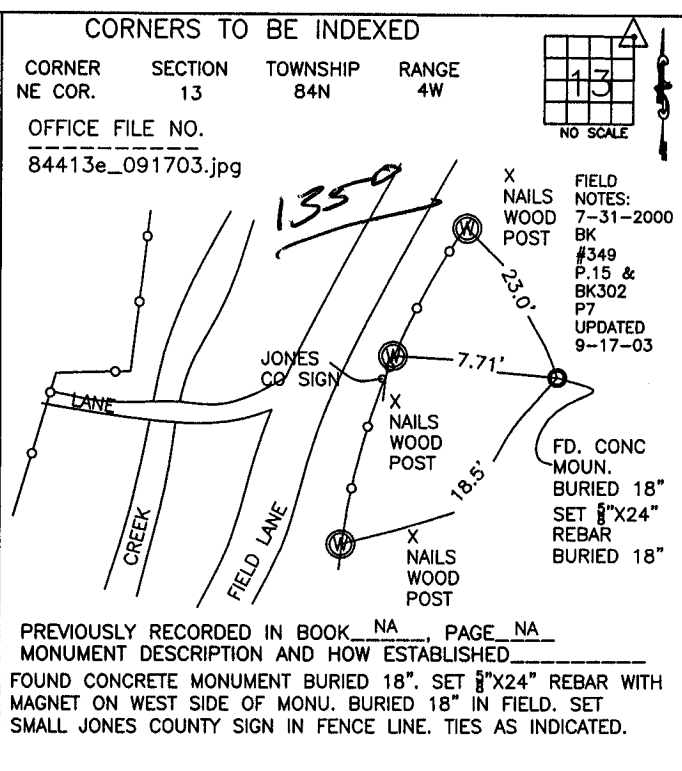
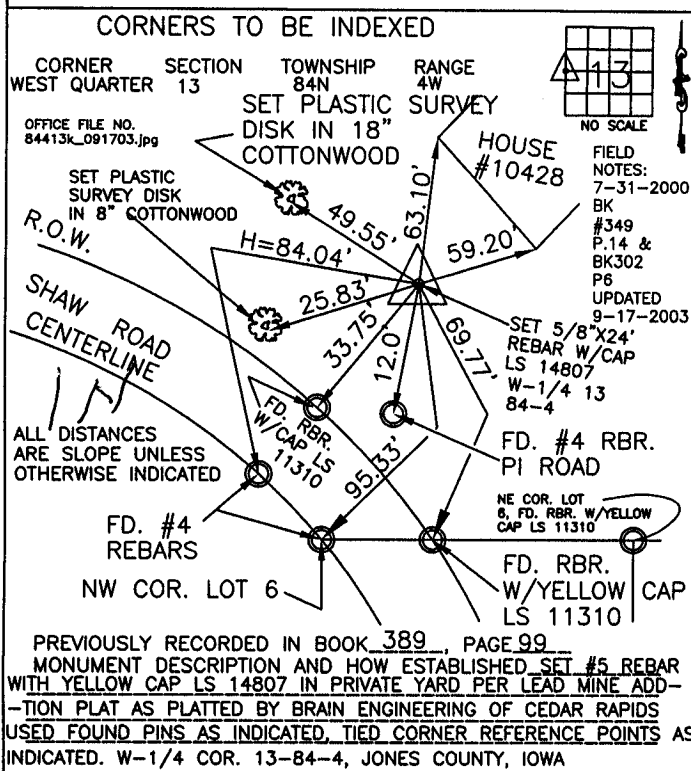

I hereby declare that this plat, survey or report was made by me or under my direct personal supervision and that I am a duly registered Land Surveyor under the laws of the State of Iowa.

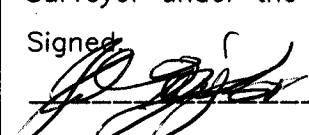
Signed  9.26.03

Joseph D. Tjepkes L.S. Iowa Reg. No. 14807  
My Registration Renewal Date is December 31, 2004

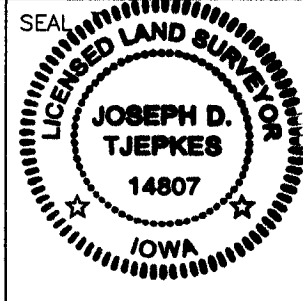

J.D. TJEPKES LS 14807  
JONES COUNTY  
ENGINEER'S OFFICE

19501 HWY. 64,  
ANAMOSA, IOWA,  
52205 (319)462-3785

Instrument #: 2014-3406  
 12/31/2014 11:29:12 AM Total Pages: 1  
 ZSC SECTION CORNER CERTIFICATE  
 Recording Fee: \$7.00 Transfer Tax: \$0  
 Marie Krutzfield, Recorder, Jones County Iowa



PREPARED BY  
 STEPHEN MICHAEL BRAIN, BRAIN ENGINEERING, INC., 1540 MIDLAND COURT NE, CEDAR RAPIDS, IOWA PH. (319) 294-9424

# UNITED STATES PUBLIC LAND SURVEY CORNER CERTIFICATE

LAND SURVEY MONUMENTS SITUATED IN SECTION 13, TOWNSHIP 84 NORTH  
 RANGE 4 WEST OF THE 5TH P.M., JONES COUNTY, IOWA.

NO SCALE

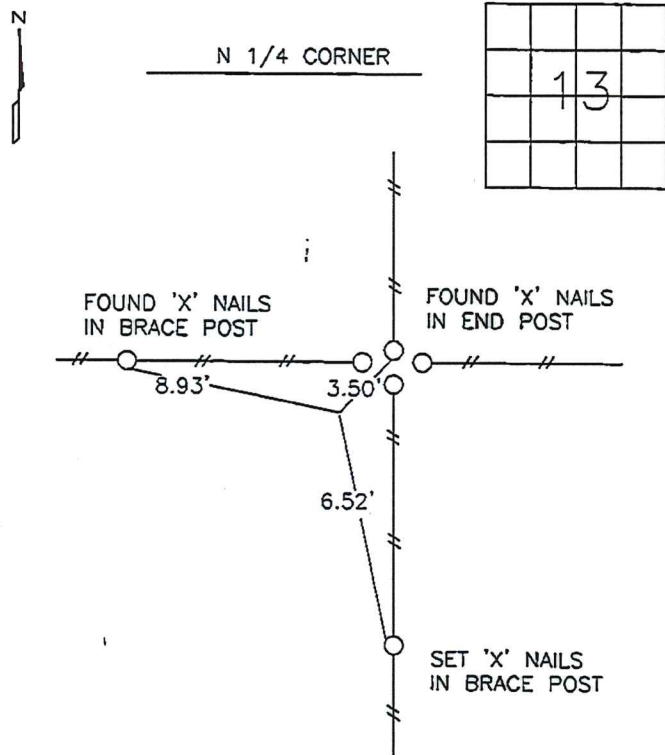

PREVIOUSLY RECORDED IN BOOK \_\_\_\_\_ PAGE \_\_\_\_\_

MONUMENT DESCRIPTION AND HOW ESTABLISHED \_\_\_\_\_  
 FOUND 1/2" REBAR 2" BELOW THE SURFACE, SET OVER THE CONCRETE MONUMENT

NO SCALE

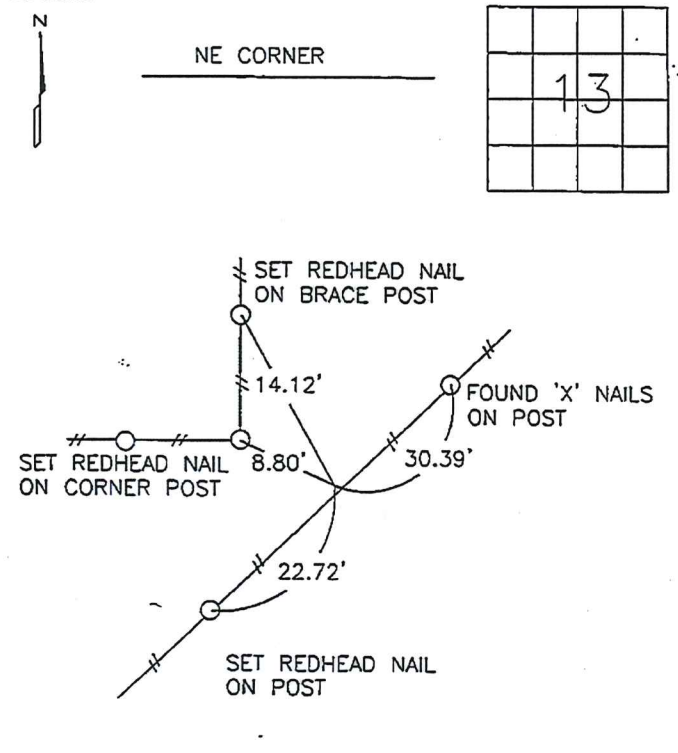

PREVIOUSLY RECORDED IN BOOK \_\_\_\_\_ PAGE \_\_\_\_\_

MONUMENT DESCRIPTION AND HOW ESTABLISHED \_\_\_\_\_  
 FOUND 4" X 4" CONCRETE MONUMENT WITH BRASS CAP WITH A REBAR FOR DETECTION 12" BELOW THE SURFACE



I hereby certify that this land surveying document and the related survey work was performed by me or under my direct personal supervision and that I am a duly licensed Land Surveyor under the laws of the State of Iowa.  
 Signed \_\_\_\_\_ Date 12/29/14

Stephen Michael Brain, L.S.  
 My License Renewal Date is December 31, 2014  
 License Number 9647  
 Pages or sheets covered by this seal: 1/1

- A. THERE IS NO CERTIFICATE FOR THE CORNER ON FILE WITH THE RECORDER OF THE COUNTY IN WHICH THE CORNER IS LOCATED
- B. THE SURVEYOR IN RESPONSIBLE CHARGE OF THE LAND SURVEYING ACCEPTS A CORNER POSITION WHICH DIFFERS FROM THAT SHOWN IN THE PUBLIC RECORDS OF THE COUNTY IN WHICH THE CORNER IS LOCATED.
- C. THE CORNER MONUMENT IS REPLACED OR MODIFIED IN ANY WAY.
- D. THE REFERENCE TIES REFERRED TO IN AN EXISTING PUBLIC RECORD ARE NOT CORRECT.

CORNERS TO BE INDEXED			
CORNER	SECTION	TOWNSHIP	RANGE
N 1/4 CORNER	13	T84N	R4 W
NE CORNER	13	T84N	R4 W

**BRAIN ENGINEERING, INC.**  
 1540 MIDLAND COURT NE  
 CEDAR RAPIDS, IOWA 52402  
 (319) 294-9424

284914-80

PREPARED BY  
 STEPHEN MICHAEL BRAIN, BRAIN ENGINEERING, INC., 1540 MIDLAND COURT NE, CEDAR RAPIDS, IOWA PH. (319) 294-9424

# UNITED STATES PUBLIC LAND SURVEY CORNER CERTIFICATE

LAND SURVEY MONUMENTS SITUATED IN SECTION 13, TOWNSHIP 84 NORTH  
 RANGE 4 WEST OF THE 5TH P.M., JONES COUNTY, IOWA.

NO SCALE



N 1/4 CORNER

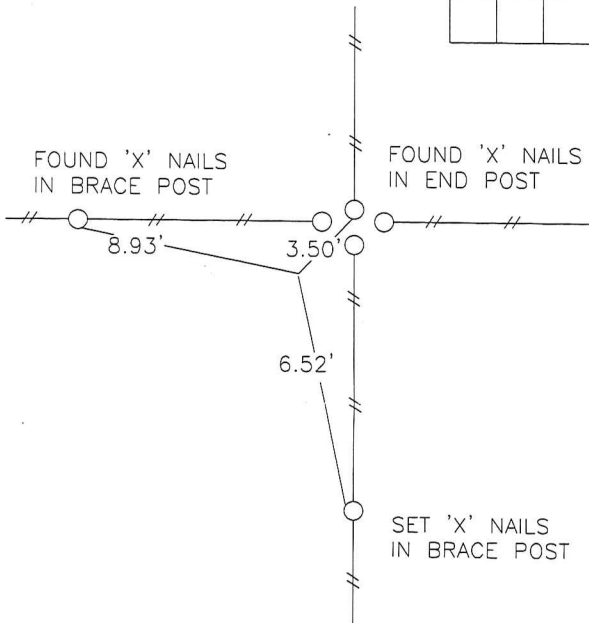
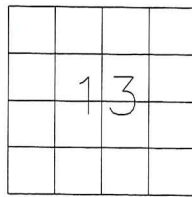

NO SCALE



NE CORNER

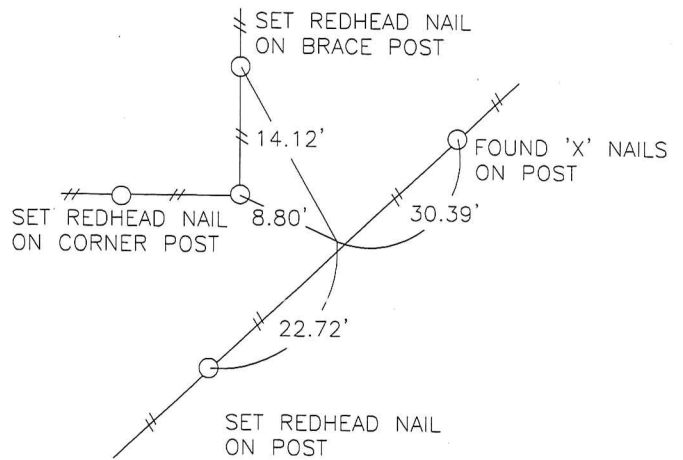
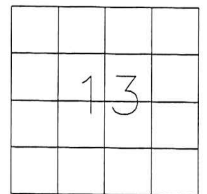

PREVIOUSLY RECORDED IN BOOK \_\_\_\_\_ PAGE \_\_\_\_\_

MONUMENT DESCRIPTION AND HOW ESTABLISHED \_\_\_\_\_  
 FOUND 1/2" REBAR 2" BELOW THE SURFACE, SET OVER  
 THE CONCRETE MONUMENT

PREVIOUSLY RECORDED IN BOOK \_\_\_\_\_ PAGE \_\_\_\_\_

MONUMENT DESCRIPTION AND HOW ESTABLISHED \_\_\_\_\_  
 FOUND 4" X 4" CONCRETE MONUMENT WITH BRASS CAP  
 WITH A REBAR FOR DETECTION 12" BELOW THE SURFACE



I hereby certify that this land surveying document and the related survey work was performed by me or under my direct personal supervision and that I am a duly licensed Land Surveyor under the laws of the State of Iowa.  
 Signed \_\_\_\_\_ Date 12/29/14

Stephen Michael Brain, L.S.  
 My License Renewal Date is December 31, 2014  
 License Number 9647  
 Pages or sheets covered by this seal: 1/1

- A.THERE IS NO CERTIFICATE FOR THE CORNER ON FILE WITH THE RECORDER OF THE COUNTY IN WHICH THE CORNER IS LOCATED
- B.THE SURVEYOR IN RESPONSIBLE CHARGE OF THE LAND SURVEYING ACCEPTS A CORNER POSITION WHICH DIFFERS FROM THAT SHOWN IN THE PUBLIC RECORDS OF THE COUNTY IN WHICH THE CORNER IS LOCATED.
- C.THE CORNER MONUMENT IS REPLACED OR MODIFIED IN ANY WAY.
- D.THE REFERENCE TIES REFERRED TO IN AN EXISTING PUBLIC RECORD ARE NOT CORRECT.

CORNERS TO BE INDEXED

CORNER	SECTION	TOWNSHIP	RANGE
N 1/4 CORNER	13	T84N	R4 W
NE CORNER	13	T84N	R4 W

BRAIN ENGINEERING, INC.

1540 MIDLAND COURT NE  
 CEDAR RAPIDS, IOWA 52402  
 (319) 294-9424

284914-80